

**Tee Lines and Hitting Mats**

**PROPERTY**

- Primary Yarn Polymer
- Yarn Cross Section
- Standard Colors
- UV Stabilized
- Fabric Construction
- Primary Backing
- Coating Type(s)
- Perforations
- Recommended Infill
- Pile Height
- Total Weight
- ISO 9001 Quality Assured
- Roll Width

**DESCRIPTION**

- Nylon; Polypropylene
- Texturized Nylon; Texturized Polypropylene
- Garden Pine
- Yes
- Cross-Stitched
- Dual layered woven polypropylene
- SilverBack™ Polyurethane
- No
- N/A
- 1 1/4"
- 142 oz.
- Yes
- 12 ft.

**ADVANTAGES**

- Holds a real tee
- Allows for a true natural swing
- Provides a divot feel with no club bounce
- Used by PGA professionals, teachers, tour players and numerous top rated facilities
- Drastically improves your golf game
- Allows for practice and play year round
- Saves your grass and your money
- Available in mats and full tee lines



## BENEFITS

The EZtee® Hybrid Plus+ features a non-infilled high grade polypropylene/nylon blended yarn system designed for heavy traffic tee lines, hitting mats, and extended use golf ranges. This product holds a real tee and allows players to hit all clubs, from a wedge to a driver and is used by many of the top golf courses around the world. EZtee® Hybrid Plus+ does not replace your natural grass, but instead gives the grass time to heal properly. When will you Experience A Greener World and a better golf facility?

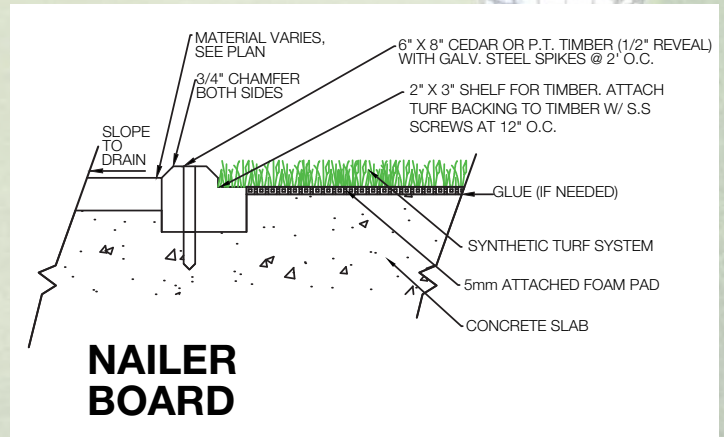
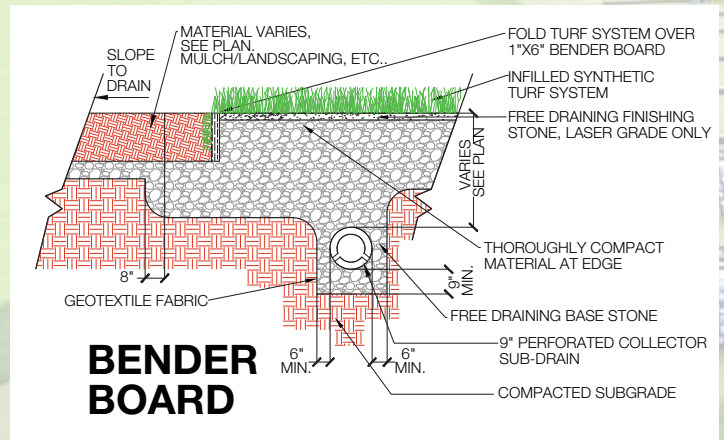

It is the policy of Synthetic Turf International to continuously improve their line of products. Therefore, Synthetic Turf International reserves the right to change, modify or discontinue systems, specifications and accessories of all products at any time without notice or obligation to purchaser. These are standard specifications subject to manufacturing tolerances and consumer requests.

